

Transport & Installation instructions



Transport instructions

4

Installation instructions

7

Parceling and Transport

1. Parceling

ARPANEL sandwich panels are piled at polystyrene foam pads. Parcels are protected by foil, mechanically supplied in the packaging machine tunnel.

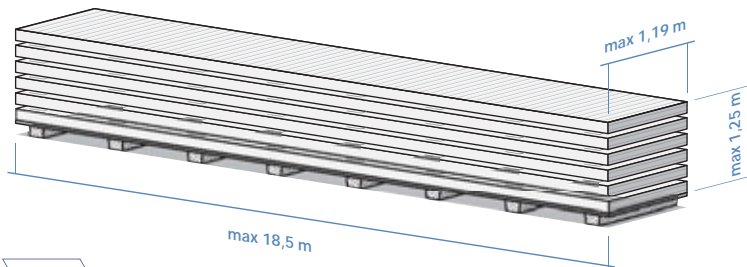

fig. 01

Maximal dimensions of parcels (fig. 01):

- Total height of the parcel – max. 1 250 mm
- Total width of the parcel – max. 1190 mm
- Length of the parcel – max. 18 500 mm
- Weight of the parcel – max. 2 000 kg

2. Acceptance of the sandwich panels

At every parcel, under the shield foil there are unloading instructions and the identification card, along with the delivery address, name of the customer and a list of panels.

For varied types of the panels ARPANEL determines min. storage term from the production date:

- ARPANEL S, D, CH, SU PUR – minimum 48 h
- ARPANEL S, D, CH, SU PIR – minimum 48 h
- ARPANEL S MiWo – minimum 24 h

3. Transport

- Transport of the ARPANEL sandwich panels can be realized only by roadworthy means of transport meeting all binding regulations for a particular vehicle;
- Vehicles must be equipped with closed container (for example with tarpaulin) loaded from the top and from the side;
- Areas of the container must be complete, smooth and clean. Structure of the walls must not have any protruding elements which could cause side damages. Rigid elements must be protected by foam pads or pads made from the polystyrene foam;
- The container must enable placement of a parcel at the entire length of the center of a vehicle;
- Parcels may protrude from the container, however not more than 1,5 m;. Panels with mineral wool core must not protrude from the container;
- It is also prohibited to transport the mineral wool panels by vehicles with the extended container;
- In case when total length of the tractor with semi-trailer and the parcel exceeds 16,5 m or total length of the set comprising the vehicle + semi-trailer with parcels exceeds 18,5 m, every carrier must have required license to carry out the transport. Means of transport enabling extension of the transport set must have and apply transport protective measures such as sliding beams assuring stiffness and continuance of the container where parcels are placed;
- Driver of a vehicle must actively participate in the loading procedure. He/she is responsible for proper placement and protection of transported pallets. It is recommended that driver checks the load after 2, 10, 50 and 100 km;

- The carrier transports the goods at own risk and shall be liable for entrusted goods. Drivers are obliged to have knowledge about the way of proper protection of sandwich panels;
- Width of the loading area equals 2,5 m and minimal height of the loading space must equal 2,6 m;
- Driver, when transporting the panels uses the uu+ vehicles, however, recommended speed when transporting panels is max. 70 km/h;
- Vehicle to be loaded must be equipped with transport belts and protective angles/corners for the belts (fig. 02), intended to secure the load at the container. Number of belts depends on length of the panels, spacing of the belts every approx. 2m. It is recommended that the vehicle is equipped with 2 sets of flat slings with eyes, 6m long and loading capacity 5 t;
- Parcels with flashings transported along with the panels must be secured individually by separate belts, apart from the packages with the panels.

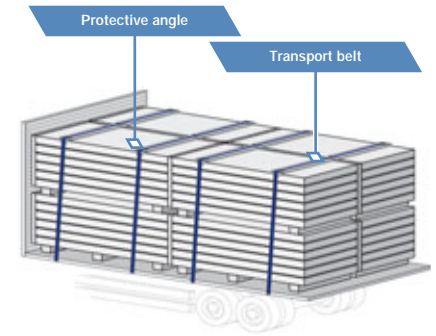

fig. 02

4. Unloading

Examination of the supplied goods:

- Visual inspection - check whether supplied goods are free from defects and accordant with the order;
- In case any deficiencies are found, enter remarks into the delivery note(WZ document) with information on no. of the pile/parcel. Moreover, found defects must be evidenced by pictures, description of damages, information on WZ document number and/or order number, pile no. and registration plates of the vehicle;
- All information send into e-mail: biuro@arpanel.eu or consult with a representative of ARPANEL.

Unloading of piles up to 6 m:

- During unloading provide support for the pile. Span equal $\frac{1}{2}$ of length of the panels; (fig. 03)
- When unloading by a forklift use the polystyrene foam pads and OSB boards if they have been attached to the transport. (fig. 04) OSB board attached to the first transport must be stored for needs of subsequent unloading of ARPANEL panels.

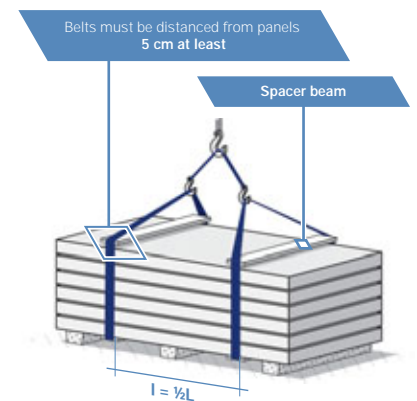
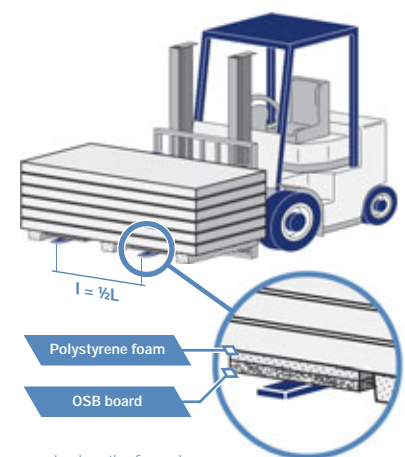

fig. 03



L = length of panels

l = distance between supports
(textile belts or fork lifts forks)

fig. 04



fig. 05

Unloading of piles exceeding 6 m:

- Unloading must take place by special frame traverse or a traverse beam, from the top of the parcel; keep distances (min. 5 cm from each side), from the bottom and from the top of the pile; (fig. 05)
- For unloading use 4 textile belts at least, polystyrene foam pads and OSB boards if they have been attached to the transport.

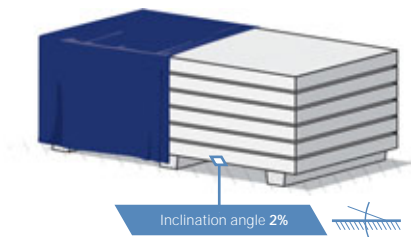

fig. 06

5. Storage

Parcels with ARPANEL sandwich panels must be stored at the construction site, slightly inclined (2%) alongside the side edge and on pads delivered from the factory. It is recommended to store the ARPANEL panels at normal temp., in closed but ventilated rooms. Storage time must not exceed 4 weeks. Storage of parcels at the fresh air is permitted exclusively in case of short storage time, provided that they have been properly protected from the rain, the wind, the snow and other contaminants. Hence, a „breathing” tarpaulin is recommended in order to remove the moisture. (fig. 06) In order to avoid dents and imprints on claddings it is prohibited to pile parcels with panels. (fig. 07)

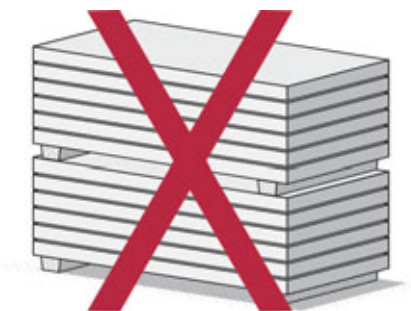

fig. 07

Installation instructions

1. Installation and weather conditions

Weather conditions such as rains and wind have a significant impact on the proper installation of the ARPANEL panels.

The sandwich panels must not be installed during a thick fog, rains, snow falls and hails. The wind speed must not exceed 4° at Beaufort's scale which is 9 m/s.

The installation must be stopped when visibility is limited and there is no artificial lightning.

Installation works must be carried out at temp. -5°C to 20°C, while works related to application of the sealing masses must be carried out at the ambient temp. exceeding 4°C.

2. OHS and the installation

The ARPANEL sandwich panels must be installed under supervision of authorized persons acc. to generally binding OHS regulations for the installation works and roof works.

Moreover, at the installation time apply tools protecting from the fall from the height, such as:

- Ropes and safety belts,
- Linear protective barriers to assure safety at the perimeter of the building,
- Safety units.

3. Placing and unloading of the sandwich panels from the parcel

- It is recommended to unload and place the ARPANEL roof sandwich panels by a lift. Give consideration to a roof downfall since there is a risk to damage the panel edge;
- In case of small unit weight of the panel, they can be unloaded and placed manually;
- Before taking a panel from the parcel and installing it at the structure, remove the protective foil from the internal cladding;
- Installers, when moving on the panels, must have shoes with a soft sole in order to avoid damages to the panels;
- In case of the roof sandwich panels ARPANEL D MiWo with the mineral wool core, apply butyl sealing mass into the panel lock in order to prevent penetration by the air and the moisture. Do not use silicones, in particular, with acid reaction;
- In order to avoid damages to the gasket, avoid min. moves at the longitudinal axis.



fig. 08



fig. 09

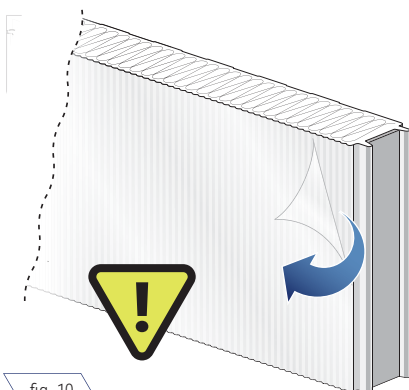

fig. 10

4. Cutting/undercutting of the sandwich panels

In order to cut the ARPANEL sandwich panels use saws with fine-tooth blade or special buzz saw blades for metal, provided they are equipped with sufficiently accurate guide systems. Chips after cutting must be removed from the area of the panels promptly. (fig. 08)

Do not use angle grinders and other tools which could result in overheating at the cutting zone, since they can damage the anti-corrosion coats. (fig. 09)

- Use only manual scissors to cut the metal sheet details.

5. Preparation for the installation

Before start of the installation of the sandwich panels ARPANEL check:

- Whether the structure has been made acc. to a design. In case of irregularities liquidate the differences;
- Whether span of purlins, poles and bolts is accordant with the design and guidelines included in the load-span tables;
- Whether the area of purlins constitute a plane;
- Whether wall structure of the object keeps the line of poles and baffles (permissible deviations acc. to PN-B-06200:2002). In case of irregularities or mistakes inform the site manager and representative of the ARPANEL;
- Performance of wet works and works related with the plinth;
- Technical condition of prepared tools necessary to install the sandwich panels.

It is important that the structure is prepared properly since it enables simple installation and correct operation of screws. Consequently, it assures proper aesthetics of the building's enclosure. It is strictly prohibited to carry out any welding works near the sandwich panels since they can damage the anti-corrosion coat.

6. Protective foil at the sandwich panels

- Claddings of the ARPANEL sandwich panels are covered, at the production process, with a protective foil to prevent dirt and damages. Normally, the wall panels are one-side foiled (external side) and in turn, the roof and wall panels with a smooth cladding are double-side foiled. The foil must be removed at the latest 3 months from the production date and within 4 weeks from the installation date. In case this term is exceeded complaints regarding the foil will be rejected. After a short time, as an effect of impact of the weather conditions the foil cracks and there can occur difficulties when trying to remove it;
- Before start of the installation start from the longitudinal edges;
- At places, where such elements are installed as flanges, skylights or drains, before the installation remove the protective foil from the panel internal cladding;
- It is prohibited to leave partially torn off foil since it may cause discoloration because of flow of the water; (fig. 10)
- Installation of the panels contrary to the instructions results in loss of the guarantee.

7. Cutting of the sandwich panels and flashings

- Cutting works regarding sandwich panels must be carried out before they have been installed, at stands with a soft material in order to protect the cladding from damages;
- Cutting of panels results in their weakening, hence, such places must be stiffened properly;
- Directly after cutting, edges of the panels and flashings cut at the construction site must be protected; Additionally, if flashings are foiled, before start of the installation remove the protective foil;
- It is strictly prohibited to cut the sandwich panels and metal-sheet flashings at roofs, scaffolding, mechanical platforms etc.

8. Screws fastening sandwich panels

To install the ARPANEL sandwich panels use self-drilling screws recommended by the manufacturer. Type of a screw depends on type and thickness of the panel. In order to fasten the panels to the structure keep the screw perpendicular when installing it. Hence, it is recommended to use drill drivers with special head intended for long screws.

The self-drilling screws made from stainless steel are used in case of installation of sandwich panels in objects, where:

- Indoor atmosphere is permanently humid (more than 70%);
- Indoor atmosphere is chemically aggressive;
- There is a need for special protection of the equipment.

Special drilling tip enables comfortable installation of the sandwich panels at the facade or a roof without preliminary drilling of holes; special self vulcanizing pad made from EPDM assures full tightness of the junction.

It is very important that, at the time of the installation, the way the screw adheres to panels is proper. It must not be screwed in too tightly or too weakly. (fig. 11)

Recommended minimal no. of screws to install one-span panel equals 2 pcs., however, each time no. of screws must be adjusted by the building designer on the basis of loads estimated by a designer.

For multi-span systems of panels it is recommended to calculate no. of screws for every support.

In case of selection of the screws for supports made from other material than the steel, please contact the ARPANEL representative.

9. General remarks regarding installation of the panels

- Installation of the panels must take place acc. to numbering of parcels and production direction. Most of all it concerns metallic color sandwich panels that is RAL 9006, RAL 9007. Turn of panels by 180° may result in color differences;

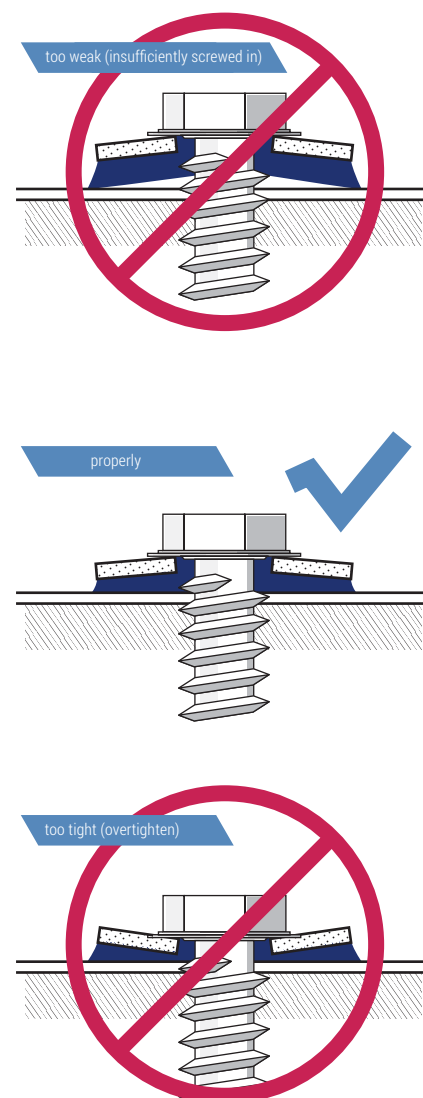

fig. 11

- During the installation works at large areas, regularly assess the colors from a distance not less than 25 m. Even small color differences are visible from larger distance from the building. During installation of panels with metallic claddings carry out such inspection frequently and from varied sides. The assessment simplifies regular removal of the protective foil;
- Because of complication of the technological processes the manufacturers of the steel claddings(sheets) do not warrant ideal match of colors from varied production lots. In order to avoid problems arising from differences in colors of the sandwich panels, before signing the contract / placement of the order buyers should determine in writing with the ARPANEL representative, which part of a contract / order concerns supplies for a single object, inform on axes of the walls and send schedule of deliveries. In case of signing the contract, ARPANEL undertakes to provide products from the same production lot for particular axes. It is also important to pay attention to potential color differences at the facade in case of panels with different thickness metal sheets installed at a particular axis. Then, one thickness metal sheets for all of types of panels at the axis are recommended. Otherwise, ARPANEL is not liable for potential differences in colors. In case of any doubts please contact ARPANEL representative.

In case varied ARPANEL panels originating from different production lots are installed at a single axis of a facade, after installation of a panel from other production lot tear off the protective foil and control whether there is a difference in color. In case of a visible difference, stop the installation and inform the ARPANEL representative promptly.

Otherwise the ARPANEL will not be responsible for potential differences in color found during or after installation of the sandwich panels.

10. Installation of the roof sandwich panels

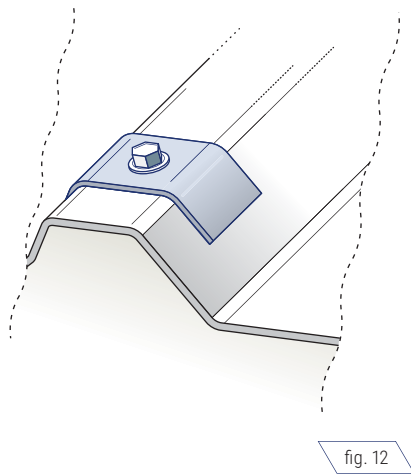

fig. 12

- Installation of the ARPANEL roof sandwich panels starts from installation of screws (one screw) to purlins below the ridge, and next to eaves and to remaining purlins. The exception is the by-ridge purlin. Intermediate panels are installed by two screws, in turn, extreme panels by three self-drilling screws in the upper part of the trapezoid;
- In order to install the roof extreme panels and intermediate ones apply the same types of the self-drilling screws;
- In order to assure proper tightness at the junction of the panels, use the sheet-metal screw to fasten sheets at the length of the junction distanced every 300 mm or acc. to recommendations of the designer;
- In order to install the roof panels the calottes are recommended. They distribute pressure forces produced by screws evenly and assure water tightness of works; (fig. 12)
- Minimal roof downfall made from ARPANEL sandwich panels equals:
 - > 5% in case of roofs where panels are installed without the junction at the length and without the roof skylights;
 - > 7% in case of roofs where panels are installed with junction at the length or the roof skylights are installed.

Before start of installation, each time check whether the width of the roof supports is accordant with assumptions of the designer.

Types of undercutting of the ARPANEL sandwich panels

Roof sandwich panels ARPANEL D PUR/PIR may be factory undercut - right or left depending on design needs. In case when length of the roof downfall tract exceeds maximal product length carry out the junction. In such a case, at the upper panel (covering) an undercut is made, equal (depending on needs) 50 - 300 mm. The undercut may also be carried out at the bottom panel in order to embed the gutter line (recommended 50 mm). On the basis of placement of so called free trapezoid, panels are called right panels and left panels, which simplifies the installation. Selecting undercuts it is necessary to determine clearly direction of the installation of the panels by calling them **left** and **right panels**. Direction of the installation must take into consideration directions of potential rains and winds.

Depending on the undercut, the roof sandwich panels ARPANEL have the following directions of the installation:

- Roof panels installed from the right side to the left one (empty „hump” on the right) - **right undercut**; (fig. 13)
- Roof panels installed from the left side to the right one (empty „hump” on the left) - **left undercut**. (fig. 14)

Determination of the side of the undercut is very significant at the time the list of undercuts is prepared. The dimension of undercut must be included in the total length of the panel because the selected type of the undercut determines the direction of the installation. In case when the sandwich panels have been manufactured with a particular side of the undercut, change of the installation direction is practically impossible, it means very serious problems during the installation process.

Ridge

After the installation of the ARPANEL sandwich panels the following operations must take place:

- Rivet the ridge internal flashing between the ridge purlins;
- Free space between the roof panels with the polyurethane core fill with polyurethane foam. After it has stiffened cut potential excess. At both sides of the ridge put the profiled gasket to the roof trapezoid; In case of roof panels with mineral wool core, free space is to be filled with butyl sealing mass and the mineral wool;
- Use sheet-metal screws or tight rivets to fasten the mask flashing, so called “comb”, to the back part of the panel, and next adhere the acoustic resistant gasket PES;
- Put the ridge external flashing at the upper part of the ridge and fasten it by sheet-metal screws.

Eaves

Eaves from the ARPANEL sandwich panels must be carried out in the following way:

Version I with PVC gutter:

- Properly drain the water from the roof plane. Hence, panels at the eaves must be equipped with eaves flashing;
- By driller, min. speed 3000 rpm with a bit of min. length 65 mm and diameter 5 mm, beneath the upper cladding cut the core crosswise the panel, and insert the montage flashing and fasten it to the lower cladding of the panel.

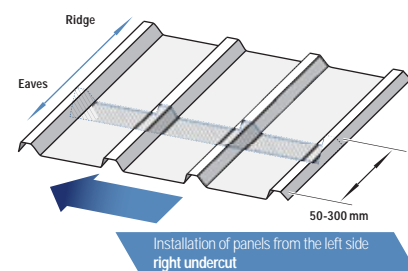
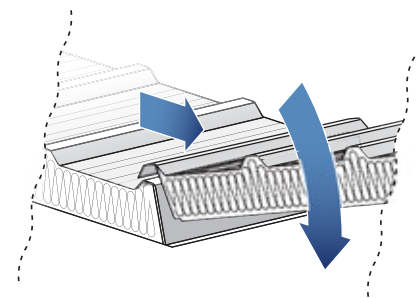

fig. 13

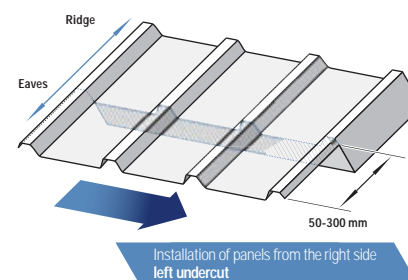

fig. 14

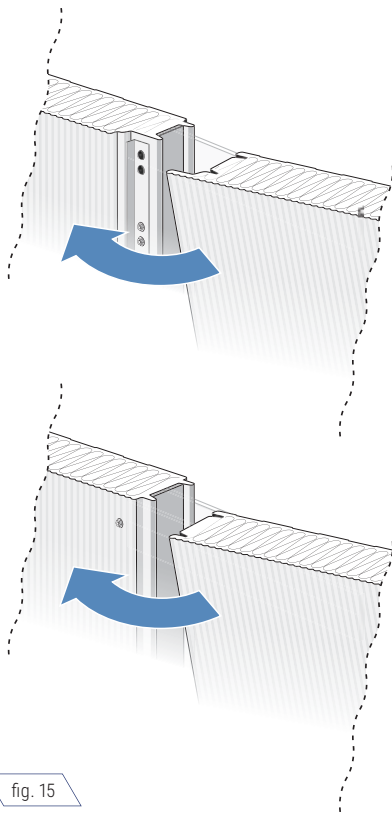

fig. 15

- Attach gutter hooks to the montage flashing; keep required downfall of the gutter. Then, press the eaves flashing under the upper panel cladding, rivet it by tight rivets and put the sealing mass alongside the flashing element;
- Insert the PCV gutters;
- Put the flashing for completing the roof trapezoid onto the panel „humps“.

Version II with a steel gutter:

- Properly drain the water from the roof plane. Hence, panels at the eaves must be finished by the eaves flashing;
- By driller, min. speed 3000 rpm, with the bit of min. length 65mm and diameter 5 mm, beneath the upper cladding cut the core crosswise the panel, and insert the eaves flashing and rivet it;
- Put the eaves flashing to the lower cladding and rivet it to the panel;
- Attach gutter hooks to the panel; pay attention to the proper downfall of the gutter, next press the steel gutter and put the sealing mass alongside the eaves flashing;
- Put the flashing for completing the roof trapezoid onto the panel „humps“.

11. Installation of the wall sandwich panels

- It is recommended to unload and place the ARPANEL wall sandwich panels by a crane;
- When using the lift use proper length sling depending on the length of the panel;
- Wall sandwich panels may also be unloaded from parcels and installed by suction devices or other equipment intended to lift the panels;
- Upper panel in the parcel must be pulled out at the length enabling drilling of a pad or a panel for bolts or attaching a tool designed to lift the panels;
- In case of small unit weight of the panel, they can be unloaded and placed manually;
- In case of double-side foiling, before start of the installation remove the protective foil from the internal cladding;
- At the ground beam install the expansion gasket PURS, and install the plinth flashing at the gasket;
- After the extreme panel has been adhered to the structure, it must be vertically leveled. Next, level the flashing and fasten the panel and the flashing (vertical system of panels) to the angle. After installation of the wall sandwich panels accurately place the extreme panel since it enables to avoid so called beveled panels fastened subsequently;
- Wall sandwich panels are installed acc. to tongue and groove method which accelerates installation of subsequent panels significantly; (fig. 15)
- Press elements each other without damaging the edges in order to assure required tightness of the longitudinal junction of the panels;
- It is important that after installation of the wall sandwich panels ARPANEL S and SU, gaskets and the lock are squeezed min. 30%, and in case of cold store panels ARPANEL CH and wall panels with the mineral wool ARPANEL S MiWo, they are pressed against each other as it is possible;
- It is important to keep linearity of vertical and horizontal junctions;
- In order to install the ARPANEL SU panels it is recommended to apply pressure distributor plates. (fig. 16)

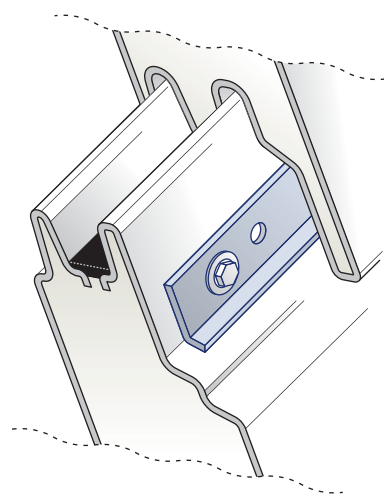

fig. 16

12. Division into the color groups

Division of the colors into the groups is related with impact of thermal loads on the enclosures made from sandwich panels. In case of darker colors, the steel external cladding at the time of exposure to the sun heats up more extensively.

Mechanical characteristics of the sandwich panels fastened to the structure is affected by the temp. difference (Δt) between the external and internal cladding resulting in thermal stress. Effect of the stress can be waving of the area, damage to the steel claddings or broken panels at the intermediate support. The standard PN-EN 14509:2013 describing the requirements for the sandwich panels regulates also division into 3 color groups: very bright, bright and dark. Value of the temperature for the external cladding depends on a color group to which a particular color is assigned and it equals:

- +55°C for very bright colors - 1st group,
- +65°C for bright colors - 2nd group,
- +80°C for dark colors - 3rd group,

For calculation the indoor temp. equal 20°C was used. At the summer season, for the external cladding the temperature was accepted on the basis of a proper color group, and in turn in the winter the accepted temp. equaled -20°C. Hence, the calculations are based on the following temp. differences:

- 1st group – $\Delta t = 40^\circ\text{C}$,
- 2nd group – $\Delta t = 45^\circ\text{C}$,
- 3rd group – $\Delta t = 60^\circ\text{C}$.

It meets requirements stipulated in the standard PN-EN 14509:2013 for our geographical location.

13. Guidelines to use the panels with a dark color claddings

In case of improper design of the light cladding systems, dark color external claddings (3rd color group) because of much higher thermal loads compared to bright colors, may become deformed. During the designing process the object designer must take this fact into accounts in order to avoid damages to the panels and to apply proper solution in order to meet 3 conditions at the same time:

1. Select a proper system of the panel installation and a static system acc. to load-span tables;
2. Limit maximal length of the sandwich panels;
3. Take installation temperature for the sandwich panels into account.

Static diagram and the installation way

Irrespective of selection of the panels acc. to load-span tables it is recommended that dark color wall sandwich panels ARPANEL are installed exclusively at single-span systems.

In case of multi-span systems, at the intermediate support certain slight waves may occur effecting from higher thermal loads. Formally permissible (by text of the standard) waves may cause potential aesthetic objections.

ARPANEL does not give a guarantee for flatness of the dark color sandwich panels applied in multi-span systems, unless it has been agreed in writing with authorized representative of ARPANEL.

Maximal lengths of panels

Wall sandwich panels ARPANEL with claddings from the 3rd color group must not exceed 9,5 m, and in case of roof sandwich panels ARPANEL 13,5 m.

ARPANEL does not give a guarantee for the dark color sandwich panels longer than the afore-mentioned ones, unless it has been agreed in writing with authorized representative of ARPANEL.

Installation temperature

It is recommended that the installation of the dark color sandwich panels ARPANEL take place at temp. exceeding 10°C, since installation at low temperatures causes increase in thermal loads in the summer season.

ARPANEL does not give a guarantee for the dark color sandwich panels installed at the temperature lower than 10°C, unless it has been agreed in writing with authorized representative of ARPANEL.

14. Guidelines to use the panels with smooth claddings

Installation of the ARPANEL wall sandwich panels with smooth claddings may take place exclusively in a single-span system, after previous consultation with ARPANEL representative.

Application of such panels in two-span or multi-span system may result in waving of the claddings. This effect may be temporary only and it occurs under certain weather conditions, e.g. in case of serious sun exposition of a facade. However, it does not affect load carrying properties of a panel.

ARPANEL does not give a guarantee for sandwich panels with smooth cladding applied in two-span or multi-span systems, unless it has been agreed in writing with authorized representative of ARPANEL.

ARPANEL shall not be responsible for damages to sandwich panels with smooth claddings arising from non-observance of guidelines by the designer.

ARPANEL

ARPANEL - Sandwich panels

Adamietz Sp. z o.o.

Braci Prankel 1

47-100 Strzelce Opolskie

Poland

NIP [Tax Id. No.]: 756 18 36 633

tel. +48 77 463 00 55

fax +48 77 463 92 00

biuro@arpanel.eu

Adamietz Sp z o.o, the producer of ARPANEL sandwich panels, is not responsible for any differences between the content of technical catalogue and the real products parameters.

The producer reserves the right to implement changes and modifications to the content without prior notice.

Pursuant to the Civil Code, the content of the product card does not constitute a commercial offer.